



# Reactor™ 2

Spray Foam and Polyurea Equipment



PROVEN QUALITY. LEADING TECHNOLOGY.

# Reactor<sup>2</sup> Revolutionary

## Advancing the industry

Like you, we want consumers to be completely satisfied with their investment in spray foam insulation and polyurea coatings. Graco's goal is to provide equipment advancements that help you and your crews apply materials accurately, as the material suppliers intended.

We want to help you grow your business. That's why Graco developed the next generation in spray foam and polyurea technology – the Reactor 2.

## Revolutionize the way you run your business

Each feature in the Reactor 2 was strategically designed to help your business, with innovations that help your operation run smoothly. Software and hardware enhancements for better spray performance. New technologies that add to your bottom line.



## Reactor<sup>2</sup> gives you:

- Better control – with Graco InSite™ remote reporting, you can manage your business wherever you are
- Better documentation – automatically collect job log data and spray parameters – lets you confirm the job was sprayed to specifications
- Better fleet and crew management
- Better cost containment and forecasting
- Compact footprint – more room in your spray rig
- Ergonomic design – easier to service
- Advanced circuit boards
- Better spraying performance compared to traditional electric Reactor systems
- Troubleshooting made quick and easy with QR codes

Reactor 2. Available in stand-alone and integrated systems.



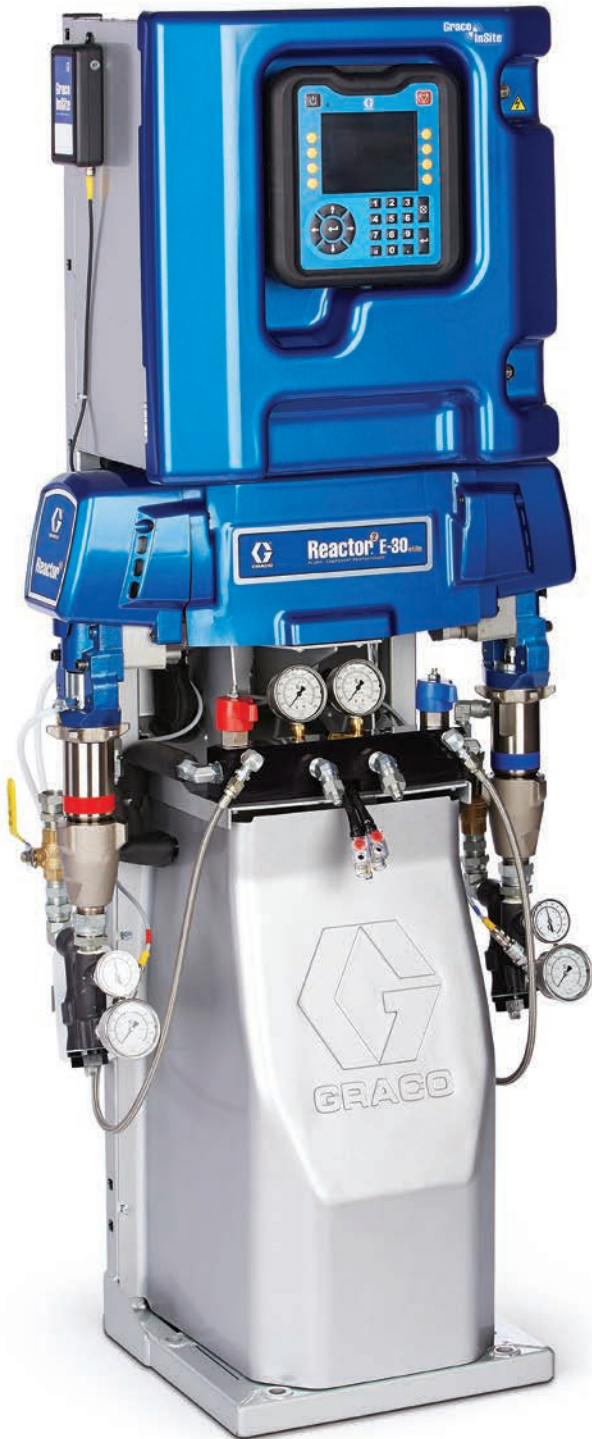

## Reactor<sup>2</sup> Top 10 List

### 1. Advanced control technology

- Tracks, monitors and saves project data
- Data can be downloaded onto a USB drive for further analysis
- Easy to view data display
- Stores up to 24 chemical recipes
- Drum level indicators

### 2. Graco InSite Remote Reporting Technology

- Transmits real-time job activity you can view on your smart phone, tablet or computer
- Lets you control your business wherever you are

### 3. Troubleshooting made easy

- On-screen troubleshooting with QR code shortcuts to web-based advanced troubleshooting info
- Results in less downtime

### 4. Compact design

- 40% smaller footprint than a traditional E-Reactor

### 5. Ergonomics

- Easy to reach, conveniently-placed electronics

### 6. Troubleshooting Y-strainer

- Analog temperature and pressure gauges

### 7. Sacrificial surge protector

- Protects your electronics against excessive power spikes
- Extra sacrificial surge protector included with Reactor 2 to get you back up and running immediately

### 8. Advanced circuit boards

- Handles power fluctuations
- Minimizes pressure fluctuations on pump changeover
- Result is a smooth, consistent spray performance similar to hydraulic systems

### 9. Brushless electric motor

- Improved control and performance
- No maintenance
- Longer life

### 10. Three-year warranty

- Covers user display module, control boards and electric motor
- One of the best in the industry

# A Closer Look at Reactor<sup>2</sup>



## Documentation to help protect your business

Tracking project data has never been easier. With Reactor 2, you can easily create job logs for each job you do. You can track the name and date of each job, material temperatures, ambient temperatures and spray pressures – in short, everything you need to confirm that the chemical was sprayed within the recommended range.

## Precise material application

Reactor 2 lets you store up to 24 recipes, so switching materials is fast, easy and trouble-free. You reduce human error in entering set points – instead you spray material as material suppliers intended.

	A	B	Q	⊗	
	*F	*F	*F	psi	Enabled
RECIPE A	32	32	32	0	<input type="checkbox"/>
RECIPE B	32	32	32	0	<input type="checkbox"/>
RECIPE C	32	32	32	0	<input type="checkbox"/>
RECIPE D	32	32	32	0	<input type="checkbox"/>
RECIPE E	32	32	32	0	<input type="checkbox"/>
RECIPE F	32	32	32	0	<input type="checkbox"/>
RECIPE G	32	32	32	0	<input type="checkbox"/>
RECIPE H	32	32	32	0	<input type="checkbox"/>



Try it now!

## Troubleshooting made easy

In the past, if you saw an unusual error code on your ADM, you might need to look it up. Reactor 2 features a new troubleshooting screen that displays a QR code. You simply scan the QR code with a smart phone or smart device, and it takes you right to a website that provides up-to-date advanced troubleshooting information. You're up and running more quickly.

## Advanced control technology

### Tracks project information

- Advanced Display module (ADM) tracks, monitors and saves project information
  - Data can be downloaded onto a USB drive for further analysis

### Easy to view data display

- Drum fluid levels – let you know if you are running low on material
  - System events such as startup and shutdown times
    - Daily chemical output

### Stores material settings to get you up and running faster

- Saves key setup data such as temperatures and pressure set points for up to 24 chemical recipes

### Reduces downtime with QR codes

- Error messages via QR codes explain the problem and provide solutions

### Flexible system settings

- If chemicals are low, or if pressure imbalance occurs, you can program the system to shut down automatically





## Better spraying performance

Reactor 2 uses software in the motor control module to intelligently smooth out pressure fluctuations on pump changeovers that are inherent to an electric driven machine. The result is a smooth, even spray that is characteristic of a hydraulic machine.

## Sleek design means more room in your spray rig

Reactor 2 is designed with a 40% smaller footprint than a traditional Reactor E-30. Which gives you extra working space in your trailer for extra gear, another Reactor – or maybe even another set of chemicals.

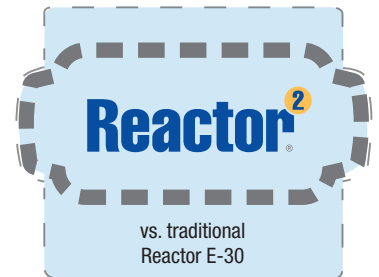

## Ergonomic setup makes it easier to service

Electronics on the Reactor 2 are located at the top of the system's cabinet. It's all within easy reach – more convenient and less awkward to get at than previous Reactor systems.

## Advanced circuit boards for peace of mind

Graco designed the electronics in the Reactor 2 to a stringent electronics reliability standard. These boards can withstand power spikes and surges.



## Sacrificial surge protector

As an added level of protection, Graco also added a sacrificial surge protector to the system. If there is an excessive spike, you only have to replace this smaller, less expensive part – not the whole electronics board. All Reactor 2 models include a spare sacrificial surge protector to get you back up and running immediately.

# Graco InSite™ Remote Reporting Technology

## The power to control your business – wherever you are

If you need to manage multiple jobsites, spend time away from the jobsite, or just want a better way to record what goes on at the jobsite, Graco InSite is your answer.

Graco InSite is remote reporting technology that lets you track jobsite activity in real time via a PC or smart device. From your smart phone, tablet or computer, see at a glance if your crews are spraying and what time they began. Verify that all spray parameters are correct. Monitor exactly how much material is being used, and do it from anywhere you can access the Internet.

## Control the direction of your business

The information Graco InSite gathers can save you money, help you bid jobs more accurately and troubleshoot problems more quickly, saving lost overhead and revenue. The data it collects is automatically stored. This data can be invaluable if you need to show that you sprayed material according to the manufacturer's specifications.

Most importantly, Graco InSite offers peace of mind that your jobs are running smoothly, your workers are productive, and you can leave the jobsite to pursue more important business matters.



### Ambient Temperature Probe

- Early warning system to alert you if chemicals are getting too cold

Name	Reactor Model	Status	Daily Material Usage (Lm)	Daily Actual Spray Time (Hours)	Daily Power On Time (Hours)	Daily Cycle Count	Cycle Count (Resettable)	Temp A (Actual/Set-point) (°F)	Temp B (Actual/Set-point) (°F)	Flow (Actual/Set-point) (°F)	Pressure A (Actual/Set-point) (Psi)	Pressure B (Actual/Set-point) (Psi)	Last Operator Date	Data and Location
V2 Spray Foam Insulation	E-30	Green	40.5	1.7	3.76	1775	4094	116 / 115	116 / 115	118 / 115	319 / 1000	359 / 1000	Dec 19, 2013 10:17:16 AM	[Icons]
V2 Glasurit UK	-	Red	0.0	---	9.83	0	Not Available	---	---	---	---	---	-	[Icons]
V2 Netherlands	E-APC	Red	3.0	0.19	3.28	144	154	---	---	---	---	---	Dec 19, 2013 3:42:31 AM	[Icons]
Poland	E-30	Red	19.0	0.6	6.9	688	689	---	---	---	---	---	Dec 19, 2013 7:28:42 AM	[Icons]
K1	E-30	Yellow	19.0	0.66	1.18	694	40294	107 / 140	142 / 140	140 / 140	1109 / 1300	1303 / 1300	Dec 19, 2013 10:36:53 AM	[Icons]
GR1	E-30	Yellow	40.0	1.47	3.89	1790	1800	105 / 103	103 / 103	---	9915 / 900	1034 / 900	Dec 19, 2013 10:17:36 AM	[Icons]
Mer1	E-30	Yellow	6.6	0.43	1.81	234	234	117 / 107	106 / 107	107 / 107	1104 / 1000	1104 / 1000	Dec 19, 2013 10:17:21 AM	[Icons]
MHC	E-30	Yellow	13.5	0.67	2.36	499	0	117 / 107	116 / 117	113 / 117	1360 / 1200	1462 / 1200	Dec 19, 2013 10:17:17 AM	[Icons]
GR2	H-25	Green	12.0	0.73	2.62	195	209	120 / 127	131 / 127	---	996 / ---	956 / ---	Dec 19, 2013 10:17:17 AM	[Icons]
Mascot1	E-30	Red	0.0	---	2.27	0	1087	---	---	---	---	---	Dec 19, 2013 1:05:14 PM	[Icons]
GR3	H-25	Green	4.0	0.52	3.36	42	42	100 / 96	95 / 93	---	883 / ---	1015 / ---	Dec 19, 2013 10:17:45 AM	[Icons]

### GPS Locator for Fleet

- See the actual GPS location of all spray rigs

### GPS Locator

- See the actual GPS location of each spray rig

### Job Log, Data Usage Log, Event Log

- Use icons to access and download detailed reports

### Temperature and Pressure Set-points

- Rest assured that conditions are fine

### Volume and Hours of Use

- See how much chemical each crew has sprayed and how long it took

### Inlet Temperature

- Records temperature and pressures of A and B materials for early troubleshooting diagnosis
- Available on Reactor 2 Elite models only

### Status lights

- Red, yellow and green say at a glance if machines are off, idling or spraying



## Better fleet and crew management

- Know when Reactors are running, idling or off
- Track productivity by crew or Reactor
- Avoid human error and time wasted by manual logging
- Follow your Reactors with GPS tracking
- Recognize unauthorized or after-hours use of Reactors or materials
- Receive real-time alerts to deviations and other parameters you define
- Receive a daily email summarizing the previous day's performance totals

## Better cost containment and forecasting

- Know when equipment is ready for maintenance by using lifetime cycle logs
- Save lost revenue and downtime by having real-time, factual information at your fingertips that can help you get up and running fast performance totals

## Better customer service

- Help troubleshoot issues remotely and get machines up and running faster
- Provide more accurate job estimates, basing it on actual data from prior jobs

## Better protection for your future

- Have documented data showing spray parameters for every job
  - Offer a final job report to customers as an additional service
  - Recognize when it's time to hire additional crews and expand your fleet
  - Schedule appointments with potential customers, knowing that you can still check on your jobsites wherever you go

*Graco InSite is standard on Elite packages or can be purchased as an accessory kit and installed easily on most existing electric and hydraulic Reactors.*

## It's simple cellular technology

Graco InSite works by transmitting your data using the local cellular network, where it is stored in the cloud. You can then view the data on your smart phone, tablet or computer via the internet.

Data is transmitted to you in real time, making it possible to receive current information on jobsite performance. If no cell connection is available near the jobsite, the information is stored on the Reactor and transmitted when a connection is established.

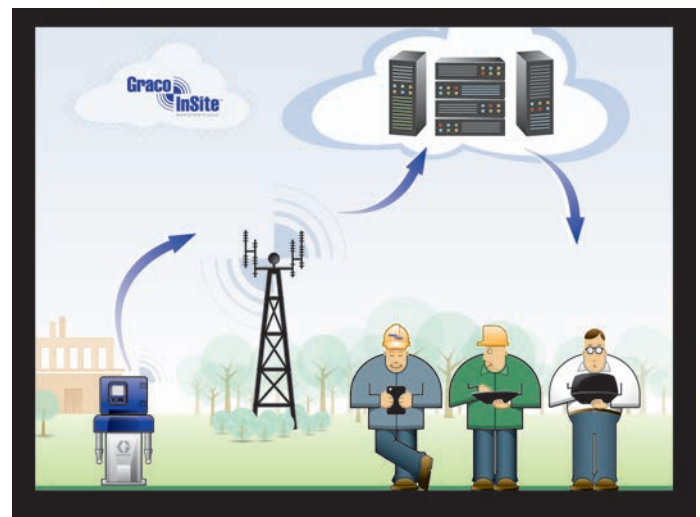

## Meet 2-Track Solutions, LLC

Graco InSite is a collaboration between Graco and 2-Track Solutions, LLC, an established leader in web-based vehicle intelligence and asset tracking. The partnership combines expertise in equipment, hardware, software development, data storage and cellular technology. Graco InSite is a subscription-based service; your subscription can be paid monthly or annually.



View a demo now!

# Ordering Information and Technical Specifications

## Reactor<sup>2</sup> Elite models include:

- Graco InSite Remote Reporting Technology
- Inlet pressure and temperature sensor (interfaces with Graco InSite)
- Xtreme-Wrap™ Scuff Guard on heated hoses for Reactor 2 packages

## Reactor<sup>2</sup> standard models include:

- Graco InSite upgradable (will not include inlet temperature and pressure)
- No inlet pressure and temperature sensor
- Standard scuff guard on heated hoses with Reactor packages

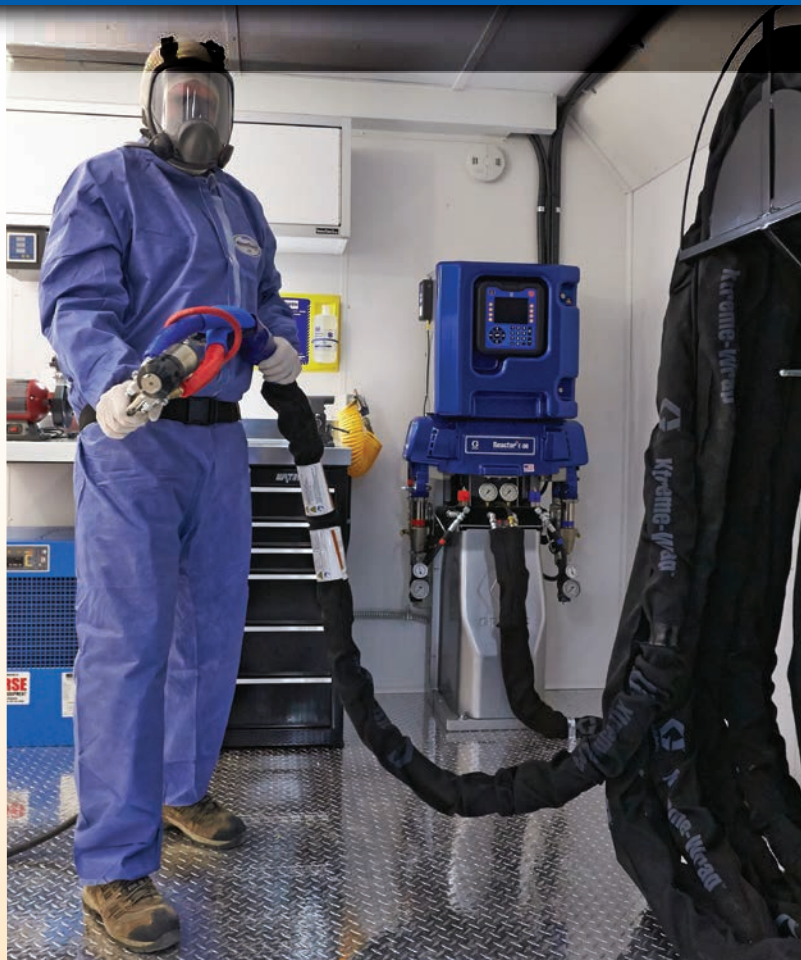

## Three-Year Extended Warranty

We stand behind every piece of equipment we manufacture with one of the industry's strongest warranties. Spray with the confidence that you will probably never need to use Graco's warranty, but if you do, we will be there.

Reactor 2 offers a three-year extended warranty on control boards, display module and electric motor. See product manuals for specific warranty details.



Three-year warranty extended



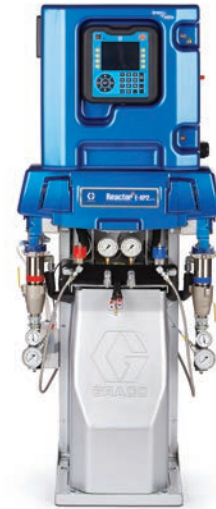

Model	SPRAY FOAM EQUIPMENT		POLYUREA EQUIPMENT	
	Reactor 2 E-30 Elite	Reactor 2 E-30	Reactor 2 E-XP2™ Elite	Reactor 2 E-XP2™
<b>Graco InSite</b>	Yes	No	Yes	No
<b>Fluid Inlet Sensors</b>	Yes	No	Yes	No
<b>Max Working Pressure bar (Mpa, psi)</b>	138 (13.8-2000)	138 (13.8-2000)	240 (24.0-3500)	240 (24.0-3500)
<b>Ordering Information</b>	<b>With 10 kW heater:</b>	<b>With 10 kW heater:</b>		
*Amps: Select 230V-1ph — 78; 230V-3ph — 50; or 400V-3ph — 34	272110 (Bare)	272010 (Bare)		
	AP2110 (AP Pkg)	AP2010 (AP Pkg)		
	CS2110 (CS Pkg)	CS2010 (CS Pkg)		
	P22110 (P2 Pkg)	P22010 (P2 Pkg)		
	<b>With 15 kW heater:</b>	<b>With 15 kW heater:</b>	<b>With 15 kW heater:</b>	<b>With 15 kW heater:</b>
*Amps: Select 230V-1ph — 100; 230V-3ph — 62; or 400V-3ph — 35	272111 (Bare)	272011 (Bare)	272112 (Bare)	272012 (Bare)
	AP2111 (AP Pkg)	AP2011 (AP Pkg)	AP2112 (AP Pkg)	AP2012 (AP Pkg)
	CS2111 (CS Pkg)	CS2011 (CS Pkg)		
	P22111 (P2 Pkg)	P22011 (P2 Pkg)	P22112 (P2 Pkg)	P22012 (P2 Pkg)
<b>Heated hose, 15 m (50 ft)</b>	24Y240	24K240	24Y241	24K241
<b>Heated hose, 3 m (10 ft)</b>	246050	246050	246055	246055
<b>Fusion® AP Gun</b>	246102	246102	246101	246101
<b>Fusion CS Gun</b>	CS02RD	CS02RD	no	no
<b>Probler® P2</b>	GCP2R2	GCP2R2	GCP2R1	GCP2R1
<b>Max Hose Length</b>	94 m (310 ft)	94 m (310 ft)	94 m (310 ft)	94 m (310 ft)
<b>Max Fluid Temp</b>	88°C (190°F)	88°C (190°F)	88°C (190°F)	88°C (190°F)
<b>Output</b>	13.5 kg/min	13.5 kg/min	7.6 lpm (2.0 gpm)	7.6 lpm (2.0 gpm)
<b>Weight</b>	161 kg	161 kg	159 kg	159 kg
<b>Operation manual</b>	333023	333023	333023	333023
<b>Repair manual</b>	333024	333024	333024	333024

\*Each model can be wired for all voltages: 230V-1ph; 230V-3ph; 400V-3ph

## Ready for the jobsite or spray rig – right out of the box

A complete system for polyurethane foam or polyurea applications, the integrated series of Reactor systems combines an electric Reactor and a diesel generator into one package. Complete turnkey models are also available with an integrated air compressor.

### Look what the integrated system can do for you:

- **Saves diesel fuel costs** – on average of 50% annually\*
- **Improves productivity** – with advanced, easy to use controls
- **Eliminates guesswork** – the system is totally engineered and tested by Graco
- **Eliminates costly power issues** – associated with shore power and low cost generators
- **Start spraying sooner** – with improved heating capacity
- **Improves spray performance** – with consistent pressure at the gun
- **Saves time** – it's easy to install into a spray rig since it's prewired with components already selected and installed
- **Reduces fuel costs even more** – compact, portable design fits into a smaller trailer and a smaller trailer means a smaller truck



## Smaller generator saves fuel costs

The integrated series of Reactor Systems uses the heat from the diesel engine to heat the A and B materials. Depending on the model, this eliminates or significantly reduces the need for electrical heaters – reducing your fuel costs. Here's how:

- The system pulls heat from the engine to heat the A and B materials
- Since there are no heaters (or only small heaters) on the equipment, this reduces the electrical demands of the generator, allowing a smaller generator to be used
- The system's smaller 22 kW generator uses less fuel than a standard 30 or 40 kW generator
- You benefit from an annual fuel savings on average of 50%\*

\* By replacing a standard 40 kW generator with a 20 kW generator, the system's fuel needs are greatly reduced. Savings are an estimate only. Actual savings may vary.

# Technology Delivers Fuel Savings

## Innovative design re-purposes wasted heat and saves energy

Graco's patent pending dual coolant loop design ensures that the A and B materials are isolated from the engine coolant. This unique design also provides constant, steady temperature control for superior heating performance.

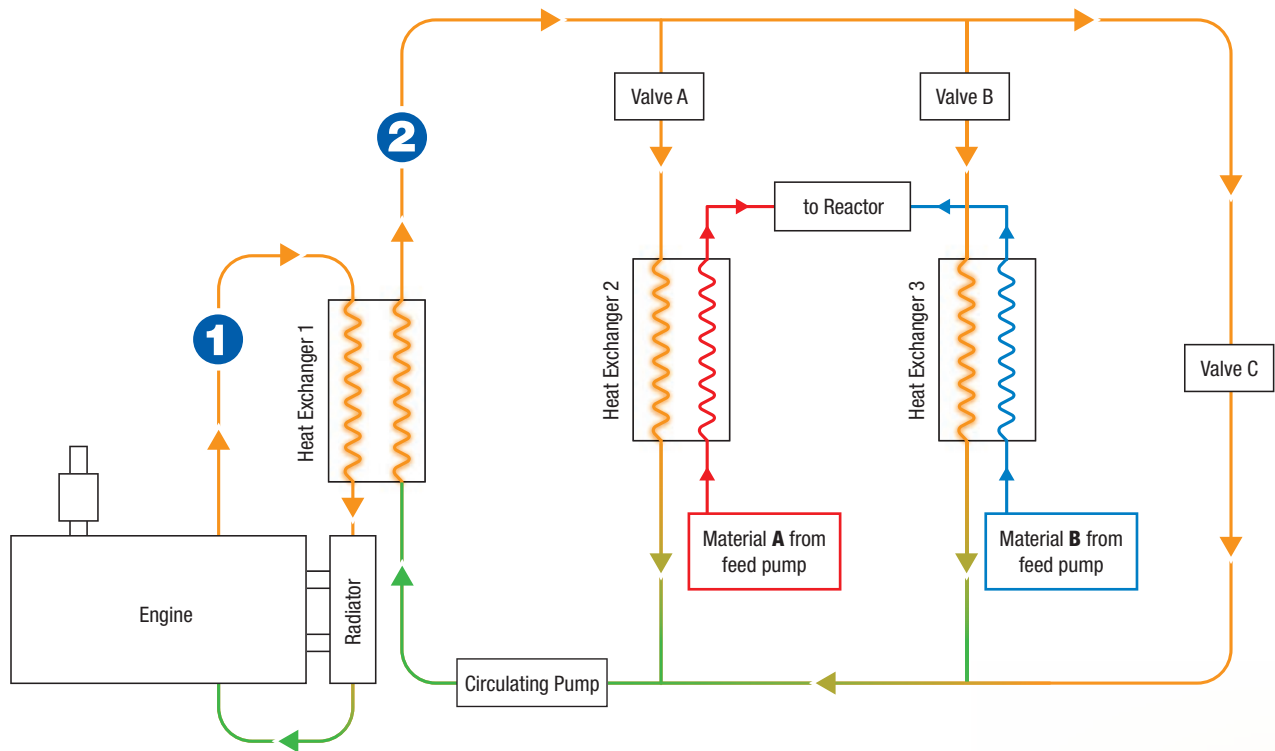

### 1 Engine coolant loop

Engine coolant goes through heat exchanger 1 and transfers the heat from the engine to the coolant in the secondary loop. Graco's controls turn the radiator fan on when additional cooling is required.

### 2 Secondary coolant loop –

Coolant in the secondary loop continually circulates when valve C is open, maintaining a consistent temperature. When material heating is required, valve C closes, and valves A and B open. This allows the coolant in the secondary loop to go through heat exchangers 2 and 3, thereby transferring the heat to the A and B materials.

### ■ Did you know...

#### *Fast material heating gets you up and running quicker*

With just one pass through the heat exchanger, materials can be heated to a Delta T (change in temperature) of 55°C (79°C on units with heaters). That's 25% greater than a standard Reactor model. Because of this better Delta T performance, you don't have to wait as long for materials to preheat.



# Advanced Technologies Save Time and Energy

## Integrated Air Control Panel

- Controls A and B feed pumps, agitator and gun
- One air line connection means less plumbing, less hoses and less assembly time

## Compact Design

- Lightweight design lets you use a smaller trailer and truck, saving you fuel costs
- Built-in pallet for easy transport
- 1.2 m wide by 1.5 m deep

## Heat Recovery System

- Recovers heat from the engine coolant and transfers it to the A and B materials

## Fluid Inlet Sensor

- Measures chemical inlet pressure and temperature
- Allows troubleshooting of fluid supply

## Troubleshooting Y-Strainer

- Easy to access
- Analog temperature and pressure gauges are standard

## Battery

- **Battery not included**

## Booster Heat

- 4000 watt heater (included on high-heat systems only)

## Gen Set Controls

- Integrated controls allow for convenient and easy start-up
- Engine monitoring functionality

## Compressor Start/Stop Switch

- Convenient access to control compressor

## Advanced Controls

- Stores up to 24 material recipes
  - Troubleshooting made easy with QR codes
- USB downloadable job data
  - User settable pressure imbalance and low chemical shutdown



## Motor Control

- Consistent pressure at the gun for improved spray performance
- Low-pulse design reduces pump change-over fluctuation



### Fuel Tank

- 83 liter capacity
- Can be remote mounted

### Distribution Panel

- Easy to service electrical controls and breakers
- Pre-wired auxiliary breakers provided for compressor and other auxiliary equipment

### Graco InSite - Remote Reporting Technology

- Transmits real-time job activity
- Tracks critical job data
- Logs spray data per job, providing proof of installation parameters

### \*Integrated Air Compressor

- Hydrovane rotary vane compressor
- Tankless air compressor

\*Standard on some models

### Gen Set

- 29 HP Perkins engine
- 22 kW Mecc Alte alternator
- Smaller engine reduces fuel consumption

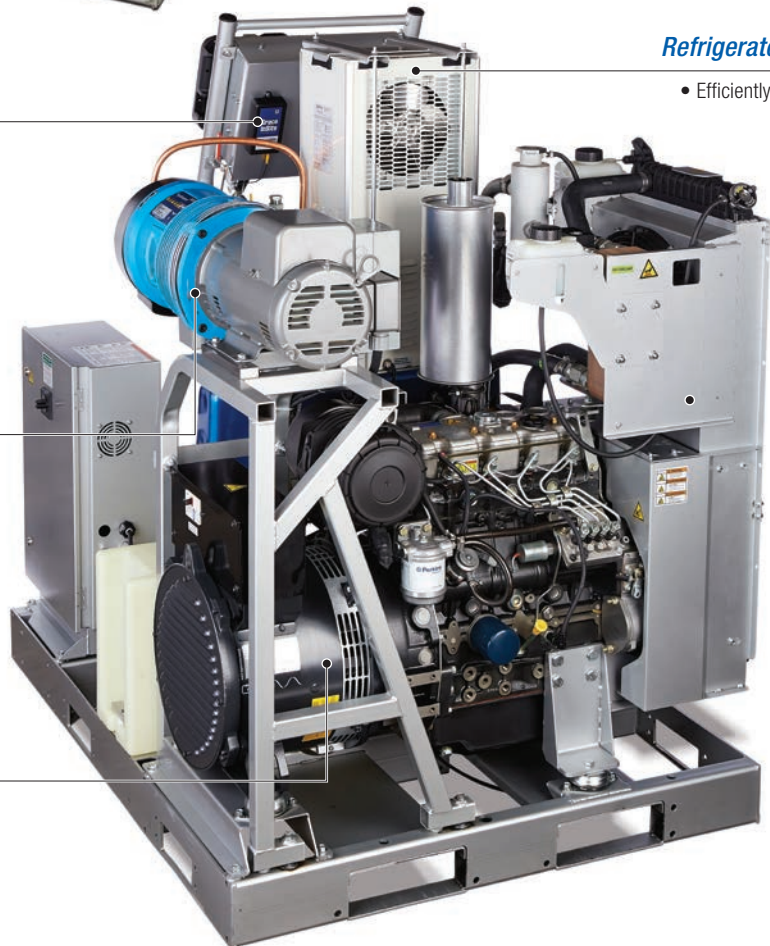

### Refrigerated Air Dryer

- Efficiently removes water from supply air



# Ordering Information and Technical Specifications

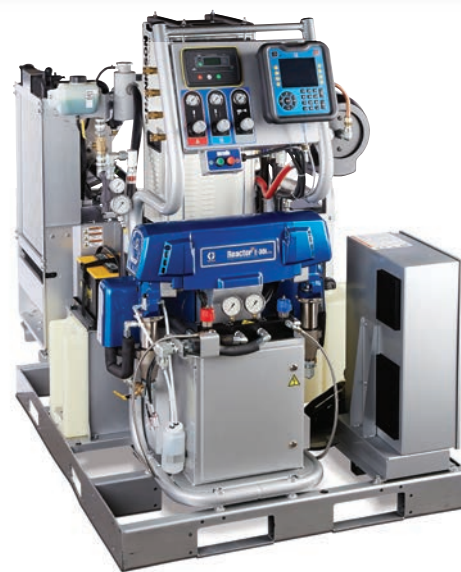

Model	NO AIR COMPRESSOR			WITH AIR COMPRESSOR			
	Reactor 2 E-30i Elite	Reactor 2 E-30i™ Elite with heat	Reactor 2 E-XP2i Elite with heat	Reactor 2 E-30i Elite	Reactor 2 E-30i Elite with heat	Reactor 2 E-XP2i™ Elite with heat	
Graco InSite	Yes	Yes	Yes	Yes	Yes	Yes	
Max Working Pressure bar (Mpa, psi)	138 (13.8-2000)	138 (13.8-2000)	240 (24.0-3500)	138 (13.8-2000)	138 (13.8-2000)	240 (24.0-3500)	
Max Hose Length	94 m (310 ft)	94 m (310 ft)	94 m (310 ft)	94 m (310 ft)	94 m (310 ft)	94 m (310 ft)	
Max Fluid Temperature	65°C (150°F)	88°C (190°F)	88°C (190°F)	65°C (150°F)	88°C (190°F)	88°C (190°F)	
Max Output	13.5 kg (30 lb)/min	13.5 kg (30 lb)/min	7.6 lpm (2 gpm)	13.5 kg (30 lb)/min	13.5 kg (30 lb)/min	7.6 lpm (2 gpm)	
Weight	794 kg	816 kg	816 kg	998 kg	1021 kg	998 kg	
Heater Wattage	NA	4000 W	4000 W	NA	4000 W	4000 W	
Auxiliary Power Available †	52 amps @ 240V	35 amps @ 240V	35 amps @ 240V	22 amps @ 240V	5 amps @ 240V	5 amps @ 240V	
Auxiliary Power	120V or 240V, 1-ph			120V or 240V, 1-ph			
Compressor	NA	NA	NA	Hydrovane 5 HP, 450 L, 240V, 1-ph, 60 Hz			
Air Dryer	NA	NA	NA	Hankison refrigerated 625 L, 115V, 1-ph, 60 Hz			
Engine	Perkins 404-22G, 2.2 L, 29 HP			Perkins 404-22G, 2.2 L, 29 HP			
Generator	Mecc Alte 22 kW, 240V, 1-ph, 60 Hz, pancake style			Mecc Alte 22 kW, 240V, 1-ph, 60 Hz, pancake style			
Ordering Information:							
Base Machine	272079	272080	272081	272089	272090	272091	
Gun Options	Fusion® AP Pkg	AP2079 (246102 gun)	AP2080 (246102 gun)	AP2081 (246101 gun)	AP2089 (246102 gun)	AP2090 (246102 gun)	AP2091 (246101 gun)
	Fusion CS Pkg	CS2079 (CS02RD gun)	CS2080 (CS02RD gun)	NA	CS2089 (CS02RD gun)	CS2090 (CS02RD gun)	NA
	P2 Pkg	P22079 (GCP2R2 gun)	P22080 (GCP2R2 gun)	P22081 (GCP2R1 gun)	P22089 (GCP2R2 gun)	P22090 (GCP2R2 gun)	P22091 (GCP2R1 gun)
Operation Manual	332636	332636	332636	332636	332636	332636	
Repair Manual	332637	332637	332637	332637	332637	332637	

Packages include spray hose, whip hose and gun

† Available auxiliary current will be less when the engine is de-rated for site altitude. Reduce the available auxiliary current by 2.5 amps per 300 m elevation increments. If the available auxiliary current is less than zero, the system configuration may not support the full load at that altitude.



# Reactor<sup>2</sup> Accessories

## Graco InSite Remote Reporting Technology

- 24T280 Graco InSite Retrofit Kit. Compatible with the following Reactor 2 models: E-30, E-XP2.
- 24T278 Graco InSite Retrofit Kit. Compatible with the following Reactor models: E-20™, E-30, E-XP1™, E-XP2, H-25™, H-40™, H-50™, H-XP2™ and H-XP3™
- 24T279 Graco InSite Retrofit Kit. Compatible with the following first generation integrated Reactor models: E-30i, E-XP2i.
- 16X521 Extension cable, 7.5 m (25 ft)



## Hoses and Hose Accessories

Protect your hoses with Xtreme-Wrap Scuff Guard. For all Reactor 2 models.

- 24T243 3 m (10 ft) Wrap Kit
- 24T244 15 m (50 ft) Wrap Kit
- 24Y240 3/8" x 15 m (50 ft) Hose, 138 bar (13.8 MPa, 2000 psi) with RTD and Xtreme-Wrap Scuff Guard
- 24Y241 3/8" x 15 m (50 ft) Hose, 240 bar (24.0 MPa, 3500 psi) with RTD and Xtreme-Wrap Scuff Guard
- 24K240 3/8" x 15 m (50 ft) Hose, 138 bar (13.8 MPa, 2000 psi) with RTD, with Scuff Guard
- 24K241 3/8" x 15 m (50 ft) Hose, 240 bar (24.0 MPa, 3500 psi) with RTD, with Scuff Guard
- 246050 1/4" x 3 m (10 ft) Whip Hose, 138 bar (13.8 MPa, 2000 psi)
- 246055 1/4" x 3 m (10 ft) Whip Hose, 240 bar (24.0 MPa, 3500 psi)
- 24N450 15 m (50 ft) RTD cable
- 24K207 Fluid Temperature Sensor with RTD

For list of all hose options, visit [www.graco.com](http://www.graco.com)



## Additional Kits and Accessories



### Hose Rack Kit

24K336

For integrated Reactor 2 systems. Supports 94 m (310 feet) of heated hose. (Some assembly required).

- 15V551 ADM Protective Covers, 10 pack
- 15M483 Remote Display Protective Covers, 10 pack
- 24U177 Feed Pump Shut Down Kit
- 24M174 Drum Level Dip Sticks, for standard 200 Liter drums

### For Reactor 2 stand-alone models

- 24U314 Wheel Kit, includes wheels, handle and brackets, Reactor 2 stand-alone only
- 24U315 Air Manifold Kit, Reactor 2 stand-alone only

### For integrated Reactor 2 systems

- 24U176 Complete air compressor, refrigerated air dryer, frames, fastener and all electrical and air connections included. Assembly required.
- 24K333 Fuel Tank/Battery Move Kit
- 24K337 Light Tower Kit
- 24U181 Booster Heat Kit, to reach temperatures above 60°C (140°F)



### Remote Display Kit 24U174

The convenience of having control at the gun. For both integrated and stand-alone Reactor 2 systems.

With a Remote Display\*, your sprayer/operator can:

- Adjust temperatures and pressures
- Turn heat zones and motor on and off
- View and clear alarms and warnings
- Place pump in park mode
- View drum level indicator
- Communicate with ADM at the equipment

\*Additional CAN cable required, hose bundles available



## ABOUT GRACO

Founded in 1926, Graco is a world leader in fluid handling systems and components. Graco products move, measure, control, dispense and apply a wide range of fluids and viscous materials used in vehicle lubrication, commercial and industrial settings.

The company's success is based on its unwavering commitment to technical excellence, world-class manufacturing and unparalleled customer service. Working closely with qualified distributors, Graco offers systems, products and technology that set the quality standard in a wide range of fluid handling solutions. Graco provides equipment for spray finishing, protective coating, paint circulation, lubrication, and dispensing sealants and adhesives, along with power application equipment for the contractor industry. Graco's ongoing investment in fluid management and control will continue to provide innovative solutions to a diverse global market.

## GRACO LOCATIONS

### MAILING ADDRESS

P.O. Box 1441  
Minneapolis, MN 55440-1441  
Tel: 612-623-6000  
Fax: 612-623-6777

### AMERICAS

#### MINNESOTA

Worldwide Headquarters  
Graco Inc.  
88-11th Avenue N.E.  
Minneapolis, MN 55413

### EUROPE

#### BELGIUM

European Headquarters  
Graco BVBA  
Industrieterrein-Oude Bunders  
Slakweidestraat 31  
3630 Maasmechelen,  
Belgium  
Tel: 32 89 770 700  
Fax: 32 89 770 777

### ASIA PACIFIC

#### AUSTRALIA

Graco Australia Pty Ltd.  
Suite 17, 2 Enterprise Drive  
Bundoora, Victoria 3083  
Australia  
Tel: 61 3 9468 8500  
Fax: 61 3 9468 8599

#### CHINA

Graco Hong Kong Ltd.  
Shanghai Representative Office  
Building 7  
1029 Zhongshan Road South  
Huangpu District  
Shanghai 200011  
The People's Republic of China  
Tel: 86 21 649 50088  
Fax: 86 21 649 50077

### INDIA

Graco Hong Kong Ltd.  
India Liaison Office  
Room 432, Augusta Point  
Regus Business Centre 53  
Golf Course Road  
Gurgaon, Haryana  
India 122001  
Tel: 91 124 435 4208  
Fax: 91 124 435 4001

### JAPAN

Graco K.K.  
1-27-12 Hayabuchi  
Tsuzuki-ku  
Yokohama City, Japan 2240025  
Tel: 81 45 593 7300  
Fax: 81 45 593 7301

### KOREA

Graco Korea Inc.  
Shinhan Bank Building  
4th Floor #1599  
Gwanyang-Dong, Dongan-Ku,  
Anyang-si, Korea 431-060  
Tel: 82 31 476 9400  
Fax: 82 31 476 9801

All written and visual data contained in this document are based on the latest product information available at the time of publication. Graco reserves the right to make changes at any time without notice.

Graco is certified ISO 9001.



**Europe**  
+32 89 770 700  
FAX +32 89 770 777  
WWW.GRACO.COM